

# boutique

## Projection Paper Holder

3155 \_\_\_\_ (specify finish)

LALOO ACCESSORIES  
SERVICE@LALOO.CA  
866-305-2566



### Available Finishes

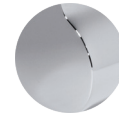

C chrome

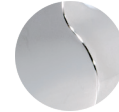

PN polished nickel

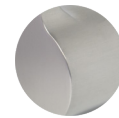

BN brushed nickel

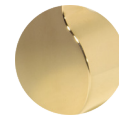

GD polished gold

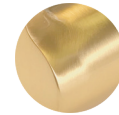

BG brushed gold



MB matte black



WF white frost

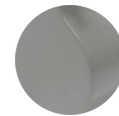

SG stone grey

Inside Paper width - 4 $\frac{7}{8}$ "

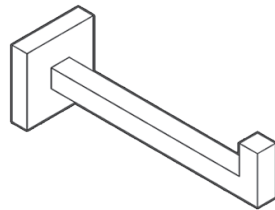
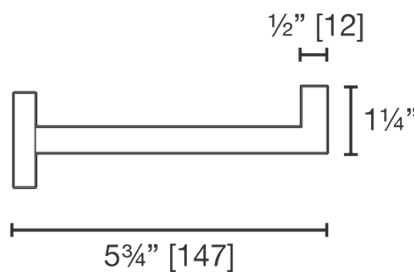
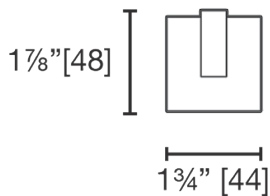
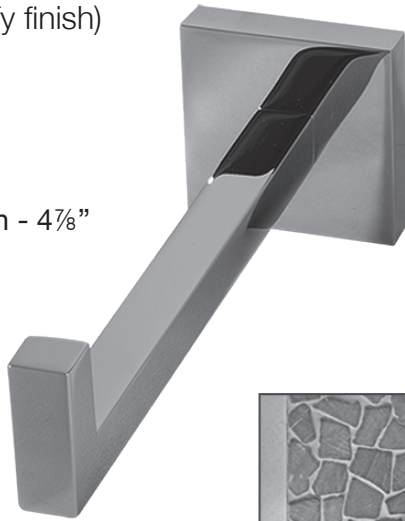

### Complementary Accessories

#### Hero Collection

(available in Chrome and Matte Black)

- small, medium towel bar
- single towel bar
- double towel bar
- towel ring
- paper holder (left & right hand opening)
- pivot paper holder
- single hook
- single glass shelf with railing



*Use metric dimensions for greatest accuracy. Specifications are subject to change without notice.*

A  
CELEBRATION  
of ART &  
FUNCTION